



## LED STAKE LIGHTS

GB IE NI

### LED STAKE LIGHTS

Operating and safety information

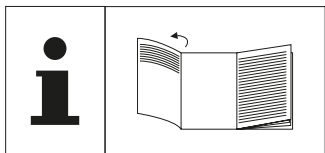

GB IE NI

Before you start reading, please fold out the illustrations page and familiarise yourself with all of the item's functions.

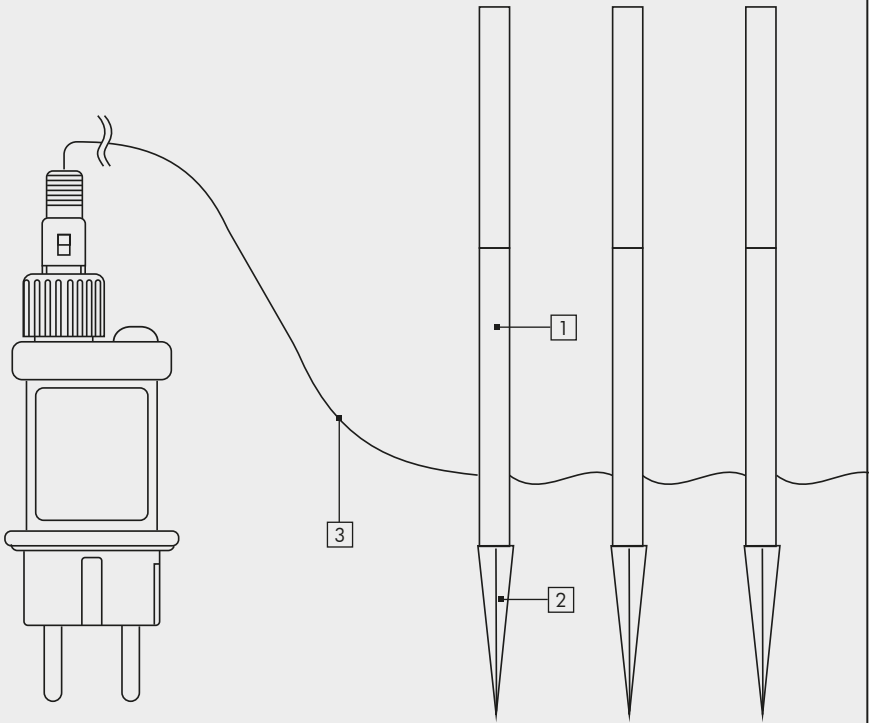
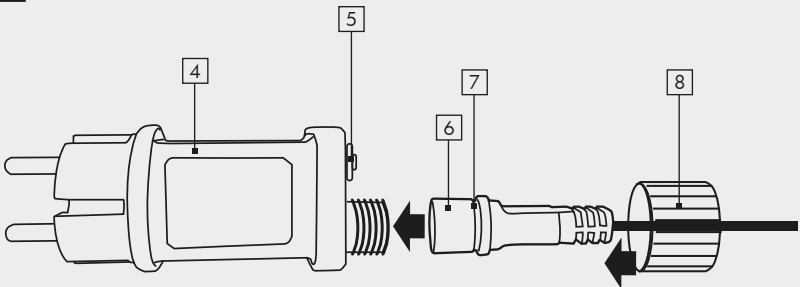
**A****B**









**Introduction** ..... 6  
**Explanation of symbols** ..... 6  
**Intended use** ..... 6  
**Specifications supplied** ..... 6  
**Description of parts** ..... 6  
**Technical data** ..... 7  
**Safety information** ..... 7  
**Assembly** ..... 7  
**Operating the LED strip lights** ..... 8  
**Cleaning and storing** ..... 8  
**Troubleshooting** ..... 8  
**Disposal** ..... 8  
**Warranty** ..... 8  
**Service** ..... 9

# LED strip lights

## ● Introduction

 Congratulations on the purchase of your new device. You have selected a high-quality product. Please read these operating instructions thoroughly and carefully. These instructions are an essential part of the product and contain important information on first-time use and handling. Always observe all safety instructions. If you have any questions or are unsure how to operate the device, please contact your dealer or service centre. Please keep this manual in a safe place and pass it on to third parties where necessary.

## ● Explanation of symbols

-  Read the operating instructions!
-  Direct current
-  Observe warning and safety instructions!
-  Risk of accidents or fatal injury for infants and children
-  Dispose of packaging and equipment in an environmentally friendly manner!
-  Risk of environmental damage from incorrect disposal of batteries
-  This symbol indicates that the product operates with safety extra-low voltage (SELV/PELV, Protection Class III).  
LED strip lights
-  Electrical devices that carry this symbol are rated as Protection Class II.  
Mains adaptor



Suitable for outdoor use

**IP44**

Protected against solid foreign objects with a size of  $\geq 1.0$  mm, splash-proof



With the CE label, the manufacturer confirms that this electrical device complies with the applicable European directives.



Mains adaptor

The "GS" symbol stands for safety-tested. Products that are marked with this symbol meet the requirements of the German Product Safety Act (Produktsicherheitsgesetz).

## ● Intended use

These articles are special products because they can be operated at temperatures below  $-21^{\circ}\text{C}$  and maintain their function.

This product is not suitable for commercial use. It is suitable for decorative use outdoors. If used outdoors, the mains adaptor should be connected to an IP44-rated socket. Use this lamp only as outlined in these user instructions. Any other use is considered use other than intended and may result in property damage or even personal injury. The lamp is not a toy. The manufacturer or dealer does not accept any liability for damage caused by use other than intended or misuse. The light is also designed for use at temperatures below zero.

## ● Specifications supplied

- 5 LED strip lights
- 1 mains adaptor
- 1 assembly and operating manual

## ● Description of parts

-  LED strip light

- 2 Ground spike
- 3 Power cable
- 4 Power supply
- 5 PRESS switch
- 6 Connection socket
- 7 Sealing ring
- 8 Sleeve nut

## ● Technical data

Protection class:	IP44
Model number:	972-B
Light source:	10lx
Illumination time:	6 - 18 hour timer
Power:	0.1W
Light output:	10lm
Length of light row:	12 m
Power cable:	5 m
Mains adaptor input voltage:	220 - 240V~, 50 - 60Hz
Mains adaptor output voltage:	4.5 V 

## ● Safety information



### Safety information







#### **⚠ WARNING!**

#### **RISK OF ACCIDENTS OR FATAL INJURY FOR INFANTS AND**

**CHILDREN!** Never leave children unsupervised with the packaging material. There is a danger of suffocation from the packaging material. Children often underestimate the dangers. Always keep children away from the product.

- This product can be used by children aged 8 years and over, as well as by persons







with limited physical, sensory or mental abilities or lacking in experience and knowledge, if they are supervised or have been instructed as to the safe use of the product and understand the resulting hazards. Do not let children play with the product. Cleaning and maintenance may not be carried out by children without proper supervision.

- Do not use the product if you notice any defects.
- The row of lights must not be connected to the mains power supply while still in the packaging.
- Once the light has reached the end of its service life, it must be disposed of in accordance with local disposal regulations. The LEDs are non-replaceable.
- The light must not be used without the sealing ring  properly fitted to the cable (see Fig. B)!
- If using the product outdoors, you should only ever connect the mains adaptor  to an IP44-rated socket (see Fig. B).
- **RISK OF INJURY!** When removing the light, make sure that you also remove the ground spike  so as to avoid any risk of injury (e.g. trip hazard) (see Fig. A).
- **TRIP HAZARD!** Please make sure that the power cable  is routed in such a way that nobody can tread on it or trip over it (see Fig. A).

## ● Assembly

**Please note:** Dispose of all packaging material.

**Please note:** Only use the mains adaptor  supplied with the product (see Fig. B).

- Fit the LED strip light  together with the ground spike  (see Fig. A).
- Now connect the power cable  to the mains adaptor  and then screw the sleeve nut  tightly onto the mains adaptor  (see Figs. A and B).

**RISK OF INJURY!** When removing the light, make sure that you also remove the ground spike [2] so as to avoid any risk of injury (e.g. trip hazard) (see Fig. A).

## ● Operating the LED strip lights

- Plug the mains adaptor supplied into an IP44-rated socket designed for the purpose. The article will light up in permanently on mode.
- To activate the timer function, press the button marked "PRESS" [5]. The button will then light up green.
- To switch off the article, press the button marked "PRESS" [5] again.

## ● Cleaning and storing

- Switch off the product by pressing the button marked "PRESS" [5] if you wish to stop using it, clean it and store it away (see Fig. B).
- Regularly inspect the LED strip lights for dirt and contamination. Remove any dirt to ensure the product works correctly.
- Clean the product with a clean, damp cloth and a mild detergent.

## ● Troubleshooting

- = Fault
- = Cause
- = Solution
- = The product fails to switch on.
- = The product is switched off.
- = Press the PRESS switch [5] to switch the product on (see Fig. B).

## ● Disposal



Note the label on the packaging materials when separating the waste, these are marked with abbreviations (a) and numbers (b)

with the following meanings:

1 - 7: Plastics

20 - 22: Paper and cardboard

80 - 98: Composites



You can obtain information on how to dispose of the used product from your local or city council.



In the interest of environmental protection, do not dispose of the product via the household waste, but rather dispose of it properly. For information on recycling centres and their opening times, please contact your local council.

## ● Warranty

Dear customer, This product comes with a 3-year warranty from the date of purchase. In the event that this product is faulty, you have legal rights against the seller of the product. These statutory rights are not restricted by our warranty as set out below.

### **Warranty terms**

The warranty period begins with the date of purchase. Please keep the original receipt in a safe place. It is required as proof of purchase. If a material or manufacturing defect occurs within three years of the date of purchase, we will repair or replace the product for you free of charge, or refund the purchase price, at our discretion. This warranty service is granted provided that the faulty device and the proof of purchase (receipt) are presented within three years, along with a brief written description of the fault and of when it occurred. If the fault is covered by our warranty, we will return the fixed product or send you a new one. No new warranty period shall begin upon repair or replacement of the product.

### **Warranty period and statutory warranty claims**

The warranty period is not renewed after a

warranty service has been granted. This rule shall also apply for any replaced or repaired parts. Any damage or faults that already existed when buying the product must be reported immediately upon unpacking the product. A fee is charged for any repairs that are carried out after the end of the warranty period.

### Warranty scope

The device was carefully manufactured according to the strictest quality guidelines and thoroughly tested before delivery. The warranty applies to material or manufacturing defects. This warranty does not apply to product parts that are subject to normal wear and tear and can therefore be regarded as wearing parts, or damage to fragile parts, such as switches, rechargeable batteries or parts that are made of glass. This warranty is void if the product has been damaged, improperly used or serviced. To ensure proper use, all instructions included in the manual must be followed carefully. All uses and actions that users are discouraged from or warned of in the manual must be avoided under all circumstances. The product is intended for private household use only, and not for commercial activities. The warranty is void, if the product is treated inappropriately, if force is applied, and in the case of any manipulation that is not carried out by our authorised service branch.

### Warranty processing

To ensure your request is handled swiftly, please observe the following

#### Notes:

- Please have the receipt and the article number (e.g. IAN 123456) ready as proof of purchase for all enquiries.
- Please refer to the type plate on the product, an engraving on the product, the cover of the manual (bottom left) or the sticker on the back or base of the product to find out the product number.

- In the case of any malfunctions or other defects, please call or email the service department indicated below as a first step.
- After your product has been registered as faulty, you can send it to the specified service address, free of charge. Please include the proof of purchase (receipt) and information about the defect and about when it occurred.

### ● Service



Service Great Britain  
Tel. : 00800 80040044  
E-Mail: [administration@mynetsend.de](mailto:administration@mynetsend.de)



Service Ireland  
Tel. : 00800 80040044  
E-Mail: [administration@mynetsend.de](mailto:administration@mynetsend.de)

**IAN 360464\_2007**

Please have the receipt and the article number (e.g. IAN 12345) ready as proof of purchase for all enquiries.

#### Notes:

- The power supply unit is intended for use as an opera,ng device for lamps.
  - This power supply unit can also be operated in no-load mode.
- You will find the latest version of the opera,ng instruc,ons on our homepage at: [citygate24.de](http://citygate24.de)



**citygate24 GmbH**

Lange Mühren 1  
20095 Hamburg  
GERMANY

Model No.: 972-B  
Manufactured: 12/2020

IAN 360464\_2007

